





7506024141314

7151-H-9

ARMADORA	MODELO			APLICACIÓN
FORD	FOCUS	L4 2.0	05-17	REPUESTO PARA SOPORTE DE MOTOR DERECHO (7151-H)
		L5 2.5	07-10	
	TRANSIT CONNECT	L5 2.0	10-13	
MAZDA	3	L4 2.0	04-10	
		L4 2.3		
	5	L4 2.3	06-11	





Parque Vehicular *87,800



7506024141680

7833

ARMADORA	MODELO			APLICACIÓN
FORD	TRANSIT	L4 2.2	07-13	SOPORTE PARA TRANSMISIÓN (DIESEL) OEM 3C117M124AD





Parque Vehicular *4,500



7506024141673

7832

ARMADORA	MODELO			APLICACIÓN
FORD	TRANSIT	L4 2.2	07-13	SOPORTE PARA MOTOR TRASERO TORQUE STRUT (DIESEL) OEM 3C116P082AC



Parque Vehicular *4,500

Las imágenes presentadas son solo de uso ilustrativo.

* El Parque Vehicular mencionado es a nivel nacional y la cifra es la suma de todos los modelos en el rango de años de fabricación.

SIGUENOS EN:

 DAI_Soportes
  @Dai_Soportes
  DAI Soportes

www.dai.com.mx



7835

ARMADORA	MODELO		29	APLICACIÓN
NISSAN	JUKE	L4 1.6	11-18	SOPORTE PARA MOTOR TRASERO TORQUE STRUT OEM 113601KC0A
	SENTRA (SR TURBO)		17-18	



Parque Vehicular *17,300

DIAGRAMAS

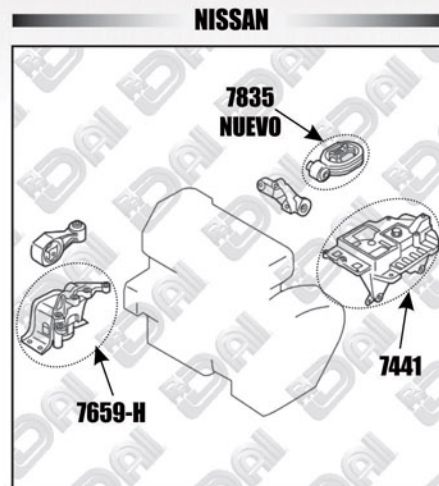
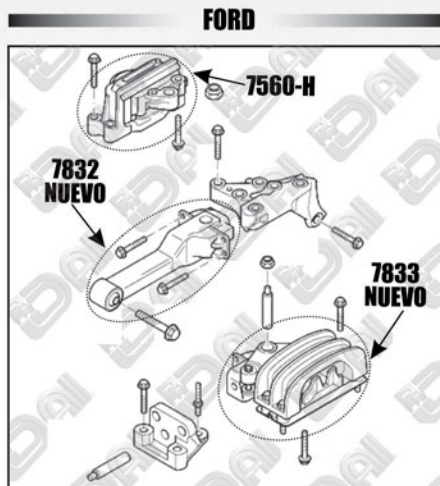

En espera de su apoyo para el buen desplazamiento de este producto, quedo de ustedes.

Atentamente

Gerente de Ventas

Las imágenes presentadas son solo de uso ilustrativo.

* El Parque Vehicular mencionado es a nivel nacional y la cifra es la suma de todos los modelos en el rango de años de fabricación.

SIGUENOS EN:

DAI_Soportes
 @Dai_Soportes
 DAI Soportes

www.dai.com.mx